

PRELIMINARY

NEC NEC LCD Technologies, Ltd.

TFT COLOR LCD MODULE

NL6448BC33-59

26.4cm (10.4 Type)

VGA

PRELIMINARY DATA SHEET 

DOD-PD-0090 (1st edition)

**All information is subject to change without notice.
Please confirm the sales representative before
starting to design your system.**

INTRODUCTION

No part of this document shall be copied in any form or by any means without the prior written consent of NEC LCD Technologies, Ltd. (hereinafter called "NEC").

NEC does not assume any liability for infringement of patents, copyrights or other intellectual property rights of third parties by or arising from use of a product described herein or any other liability arising from use of such application. No license, express, implied or otherwise, is granted under any patents, copyrights or other intellectual property rights of NEC or of others.

While NEC has been making continuous effort to enhance the reliability of its products, the possibility of failures cannot be eliminated entirely. To minimize risks of damage to property or injury to person arising from a failure in an NEC product, customers must incorporate sufficient safety measures in their design, such as redundancy, fire-containment and anti-failure features.

NEC products are classified into the following three quality grades:

"Standard", "Special", "Specific"

The *"Specific"* quality grade applies only to applications developed based on a customer designated "quality assurance program" for a specific application. The recommended applications of a product depend on its quality grade, as indicated below. Customers must check the quality grade of each application before using it in a particular application.

Standard: Computers, office equipment, communications equipment, test and measurement equipment, audio and visual equipment, home electronic appliances, machine tools, personal electronic equipment and industrial robots

Special: Transportation equipment (automobiles, trains, ships, etc.), traffic control systems, anti-disaster systems, anti-crime systems, safety equipment and medical equipment (not specifically designed for life support)

Specific: Military systems, aircraft, aerospace equipment, submersible repeaters, nuclear reactor control systems, life support systems (medical equipment, etc.) and any other equipment

The quality grade of this product is *"Standard"* unless otherwise specified in this document. If customers intend to use this product for applications other than those specified for *"Standard"* quality grade, they should contact NEC sales representative in advance.

CONTENTS

INTRODUCTION	2
1. OUTLINE	4
1.1 STRUCTURE AND PRINCIPLE	4
1.2 APPLICATIONS	4
1.3 FEATURES	4
2. GENERAL SPECIFICATIONS	5
3. BLOCK DIAGRAM	6
4. DETAILED SPECIFICATIONS	7
4.1 MECHANICAL SPECIFICATIONS	7
4.2 ABSOLUTE MAXIMUM RATINGS	7
4.3 ELECTRICAL CHARACTERISTICS	8
4.3.1 Driving for LCD panel signal processing board	8
4.3.2 Working for backlight lamp.....	9
4.3.3 Power supply voltage ripple.....	10
4.3.4 Fuse	10
4.4 POWER SUPPLY VOLTAGE SEQUENCE.....	11
4.4.1 Sequence for LCD panel signal processing board.....	11
4.4.2 Sequence for backlight inverter (Option).....	11
4.5 CONNECTIONS AND FUNCTIONS FOR INTERFACE PINS	12
4.5.1 LCD panel signal processing board	12
4.5.2 Backlight lamp	13
4.5.3 Positions of plugs and a socket	13
4.6 DISPLAY COLORS AND INPUT DATA SIGNALS	14
4.7 DISPLAY POSITIONS	15
4.8 SCANNING DIRECTIONS	15
4.9 INPUT SIGNAL TIMINGS FOR LCD PANEL SIGNAL PROCESSING BOARD	16
4.9.1 Outline of input signal timings.....	16
4.9.2 Timing characteristics	17
4.9.3 Input signal timing chart	19
4.10 OPTICS.....	22
4.10.1 Optical characteristics for transmissive mode.....	22
4.10.2 Definition of contrast ratio	23
4.10.3 Definition of luminance uniformity.....	23
4.10.4 Definition of response times.....	23
4.10.5 Definition of viewing angles	23
5. RELIABILITY TESTS	24
6. PRECAUTIONS	25
6.1 MEANING OF CAUTION SIGNS	25
6.2 CAUTIONS	25
6.3 ATTENTIONS.....	25
6.3.1 Handling of the product.....	25
6.3.2 Environment	26
6.3.3 Characteristics	26
6.3.4 Other.....	26
7. OUTLINE DRAWINGS	27
7.1 FRONT VIEW	27
7.2 REAR VIEW.....	28

1. OUTLINE

1.1 STRUCTURE AND PRINCIPLE

NL6448BC33-59 module is composed of the amorphous silicon thin film transistor liquid crystal display (a-Si TFT LCD) panel structure with driver LSIs for driving the TFT (Thin Film Transistor) array and a backlight.

The a-Si TFT LCD panel structure is injected liquid crystal material into a narrow gap between the TFT array glass substrate and a color-filter glass substrate.

Color (Red, Green, Blue) data signals from a host system (e.g. PC, signal generator, etc.) are modulated into best form for active matrix system by a signal processing board, and sent to the driver LSIs which drive the individual TFT arrays.

The TFT array as an electro-optical switch regulates the amount of transmitted light from the backlight assembly, when it is controlled by data signals. Color images are created by regulating the amount of transmitted light through the TFT array of red, green and blue dots.

1.2 APPLICATIONS

- General display terminal

1.3 FEATURES

- High luminance
- High contrast
- 6-bit digital RGB signals
- DE (Data enable) function
- Reversible-scan direction
- Edge light type (Inverter less)
- Replaceable lamp for backlight
- Acquisition product for UL60950 3rd edition/CSA C22.2 No.60950 (File number: E170632)

2. GENERAL SPECIFICATIONS

Display area	211.2 (W) × 158.4 (H) mm (typ.)								
Diagonal size of display	26 cm (10.4 inches)								
Drive system	a-Si TFT active matrix								
Display color	262,144 colors								
Pixel	640 (H) × 480 (V) pixels								
Pixel arrangement	RGB (Red dot, Green dot, Blue dot) vertical stripe								
Dot pitch	0.11 (W) × 0.33 (H) mm								
Pixel pitch	0.33 (W) × 0.33 (H) mm								
Module size	243.0 (W) × 185.1 (H) × 10.5 (D) mm (typ.)								
Weight	TBD g (typ.)								
Contrast ratio	600:1 (typ.)								
Viewing angle	At the contrast ratio 10:1 <ul style="list-style-type: none"> • Horizontal: Right side 70° (typ.), Left side 70° (typ.) • Vertical: Up side 45° (typ.), Down side 55° (typ.) 								
Designed viewing direction	At DPS= Low or Open: Normal scan <ul style="list-style-type: none"> • Viewing direction without image reversal: up side (12 o'clock) • Viewing direction with contrast peak: down side (6 o'clock) • Viewing angle with optimum grayscale ($\gamma=2.2$): normal axis 								
Polarizer surface	Clear								
Polarizer pencil-hardness	3H (min.) [by JIS K5400]								
Color gamut	At LCD panel center 43 % (typ.) [against NTSC color space]								
Response time	Ton (white 90%→black 10%) TBD ms (typ.)								
Luminance	At IBL= 5.0mAmps / lamp 450 cd/m ² (typ.)								
Signal system	6-bit digital signals for data of RGB colors, Dot clock (CLK), Data enable (DE), Horizontal synchronous signal (Hsync), Vertical synchronous signal (Vsync)								
Power supply voltage	LCD panel signal processing board: 3.3V or 5.0V								
Backlight	Edge light type: 2 cold cathode fluorescent lamps <table style="margin-left: 20px; border: none;"> <tr> <td style="border-left: 1px solid black; border-right: 1px solid black; padding: 0 10px;">Replaceable part</td> <td style="border: none;"></td> </tr> <tr> <td style="border-left: 1px solid black; border-right: 1px solid black; padding: 0 10px;">• Lamp holder set: Type No. TBD</td> <td style="border: none;"></td> </tr> </table> <table style="margin-left: 20px; border: none;"> <tr> <td style="border-left: 1px solid black; border-right: 1px solid black; padding: 0 10px;">Recommended inverter (Option)</td> <td style="border: none;"></td> </tr> <tr> <td style="border-left: 1px solid black; border-right: 1px solid black; padding: 0 10px;">• Inverter: Type No.: 104PW161, 104PW191</td> <td style="border: none;"></td> </tr> </table>	Replaceable part		• Lamp holder set: Type No. TBD		Recommended inverter (Option)		• Inverter: Type No.: 104PW161, 104PW191	
Replaceable part									
• Lamp holder set: Type No. TBD									
Recommended inverter (Option)									
• Inverter: Type No.: 104PW161, 104PW191									
Power consumption	At IBL= 5.0mAmps / lamp and checkered flag pattern TBD W (typ.) (Power dissipation of the inverter does not include.)								

3. BLOCK DIAGRAM

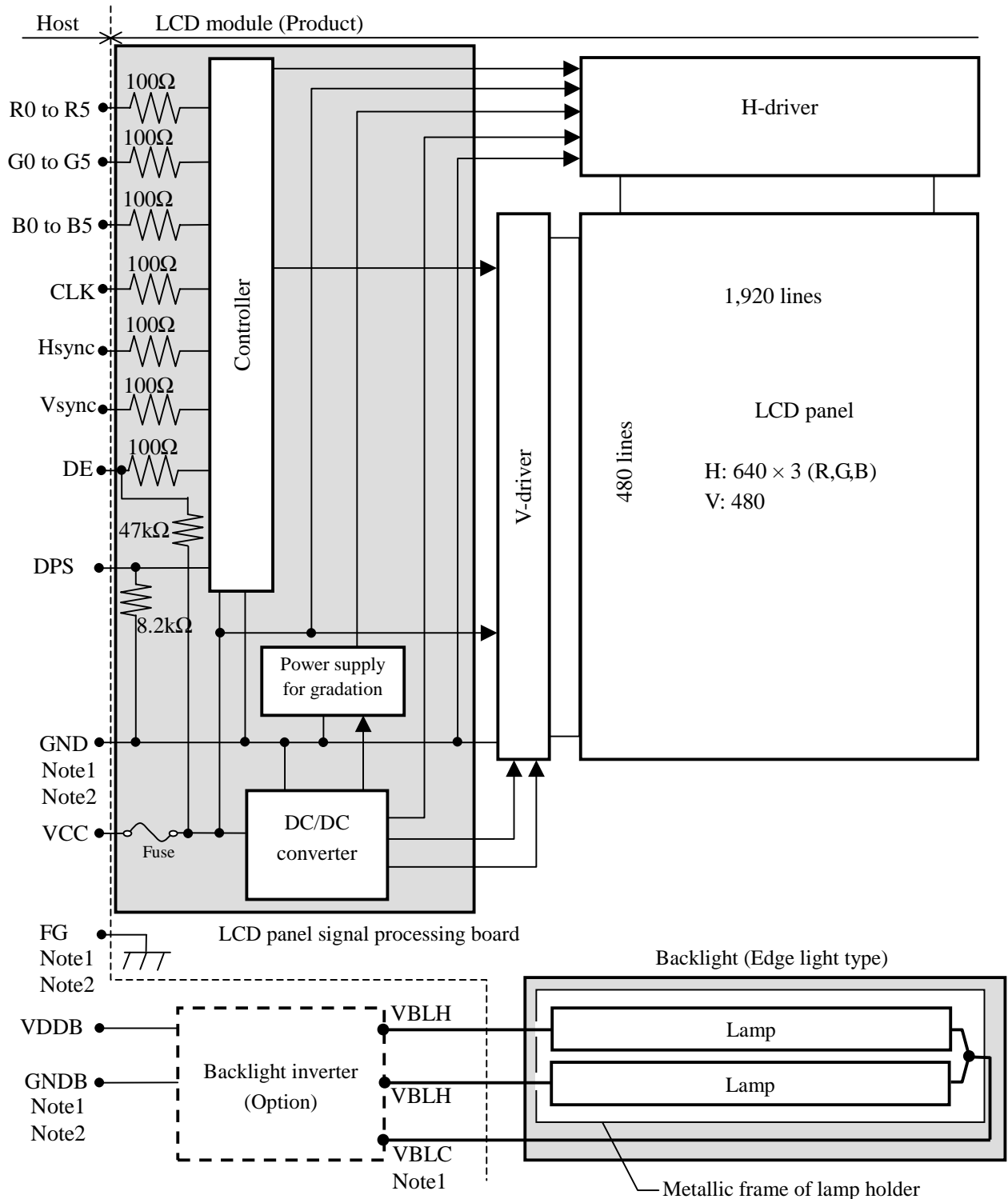

Note1: Connections between GND (Signal ground), FG (Frame ground) and VBLC (Lamp low voltage terminal) in the LCD module

GND - FG	Not connected
GND - VBLC	Not connected
FG - VBLC	Not connected

Note2: GND, FG and GNDB should be connected together in customer equipment.

4. DETAILED SPECIFICATIONS

4.1 MECHANICAL SPECIFICATIONS

Parameter	Specification	Unit
Module size	243.0 ± 0.5 (W) × 185.1 ± 0.5 (H) × 10.5 ± 0.5 (D) Note1	mm
Display area	211.2 (W) × 158.4 (H) Note1	mm
Weight	TBD (typ.), TBD (max.)	g

Note1: See "7. OUTLINE DRAWINGS".

4.2 ABSOLUTE MAXIMUM RATINGS

Parameter		Symbol	Rating	Unit	Remarks
Power supply voltage	LCD panel signal processing board	VCC	-0.3 to +6.5	V	Ta = 25°C
	Lamp voltage	VBLH	1,500	Vrms	
Input voltage for signals	Display signals Note1	VD	-0.3 to VCC+0.3	V	
	Function signal Note2	VF	-0.3 to VCC+0.3	V	
Storage temperature		Tst	-20 to +80	°C	-
Operating temperature	Front surface	TopF	-10 to +70	°C	Note3
	Rear surface	TopR	-10 to +70	°C	Note4
Relative humidity Note5		RH	≤ 95	%	Ta ≤ 40°C
			≤ 85	%	40 < Ta ≤ 50°C
Absolute humidity Note5		AH	≤ 70 Note6	g/m ³	Ta > 50°C

Note1: Display signals are CLK, Hsync, Vsync, DE, R0 to R5, G0 to G5 and B0 to B5.

Note2: Function signal is DPS.

Note3: Measured at center of LCD panel surface (including self-heat)

Note4: Measured at center of LCD module's rear shield surface (including self-heat)

Note5: No condensation

Note6: Ta = 50°C, RH = 85%

4.3 ELECTRICAL CHARACTERISTICS

4.3.1 Driving for LCD panel signal processing board

(Ta = 25°C)

Parameter	Symbol	min.	typ.	max.	Unit	Remarks
Power supply voltage	VCC	3.0	3.3	3.6	V	at VCC = 3.3V
		4.75	5.0	5.25	V	at VCC = 5.0V
Power supply current	ICC	-	TBD Note1	TBD Note2	mA	at VCC = 3.3V
		-	TBD Note1	TBD Note2	mA	at VCC = 5.0V
Logic input voltage for display signals	Low	VDL	0	-	0.3VCC	CMOS level
	High	VDH	0.7VCC	-	VCC	
Input voltage for DPS signal	Low	VFL	0	-	0.3VCC	
	High	VFH	0.7VCC	-	VCC	

Note1: Checkered flag pattern [by EIAJ ED-2522]

Note2: Pattern for maximum current

4.3.2 Working for backlight lamp

(Ta=25°C, Note1)

Parameter	Symbol	min.	typ.	max.	Unit	Remarks
Lamp current	IBL	2.0	5.0	5.5	mArms	at IBL=5.0mArms: 450cd/m ² Note3, Note4
Lamp voltage	VBLH	-	520	-	Vrms	Note2, Note3
Lamp starting voltage	VS	850	-	-	Vrms	Ta = 25°C Note2, Note3
		1100	-	-	Vrms	Ta = -10°C Note2, Note3
Oscillation frequency	FO	50	-	70	kHz	Note5

Note1: This product's backlight consists of 2 lamps, and these specifications are for each lamp.

Note2: The lamp voltage cycle between lamps should be kept on a same phase. "VS" and "VBLH" are the voltage value between low voltage side (Cold) and high voltage side (Hot).

Note3: The asymmetric ratio of working waveform for lamps (Lamp voltage peak ratio, Lamp current peak ratio and waveform space ratio) should be less than 5 % (See the following figure.). If the waveform is asymmetric, DC (Direct current) element apply into the lamp. In this case, a lamp lifetime may be shortened, because a distribution of a lamp enclosure substance inclines toward one side between low voltage terminal (Cold terminal) and high voltage terminal (Hot terminal).

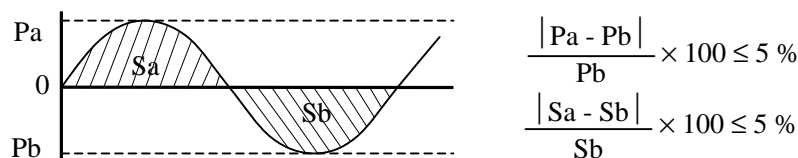

Pa: Supply voltage/current peak for positive, Pb: Supply voltage/current peak for negative
Sa: Waveform space for positive part, Sb: Waveform space for negative part

Note4: This product consists of 2 lamps. 2 lamps contain in the 1 lamp holder, and both lamps are connected to 1 low voltage cable. Lamp current must be 5.0mArms typical for each lamp, and sum of 2 lamps must be 10mArms typical. The lamp current should be measured by high-frequency current meter at the low voltage terminal.

Note5: In case "FO" is not the recommended value, beat noise may display on the screen, because of interference between "FO" and "1/th". Recommended value of "FO" is as following.

$$FO = \frac{1}{4} \times \frac{1}{th} \times (2n-1)$$

th: Horizontal synchronous cycle (See "4.9 INPUT SIGNAL TIMINGS FOR LCD PANEL SIGNAL PROCESSING BOARD".)

n: Natural number (1, 2, 3)

Note6: Method of lamp cable installation may invite fluctuation of lamp current and voltage or asymmetric of lamp working waveform. When designing method of lamp cable installation, evaluate the fluctuation of lamp current, voltage and working waveform sufficiently.

4.3.3 Power supply voltage ripple

This product works, even if the ripple voltage levels are beyond the permissible values as following the table, but there might be noise on the display image.

Parameter	Power supply voltage	Ripple voltage (Measure at input terminal of power supply)	Note1	Unit
VCC	3.3 V	≤ 100		mVp-p
	5.0 V	≤ 100		mVp-p

Note1: The permissible ripple voltage includes spike noise.

4.3.4 Fuse

Parameter	Fuse		Rating	Fusing current	Remarks
	Type	Supplier			
VCC	FCC16162AB	KAMAYA ELECTRIC Co.,Ltd.	1.6A	3.2A	Note1
			32V		

Note1: The power supply capacity should be more than the fusing current. If the power supply capacity is less than the fusing current, the fuse may not blow for a short time, and then nasty smell, smoking and so on may occur.

4.4 POWER SUPPLY VOLTAGE SEQUENCE

4.4.1 Sequence for LCD panel signal processing board

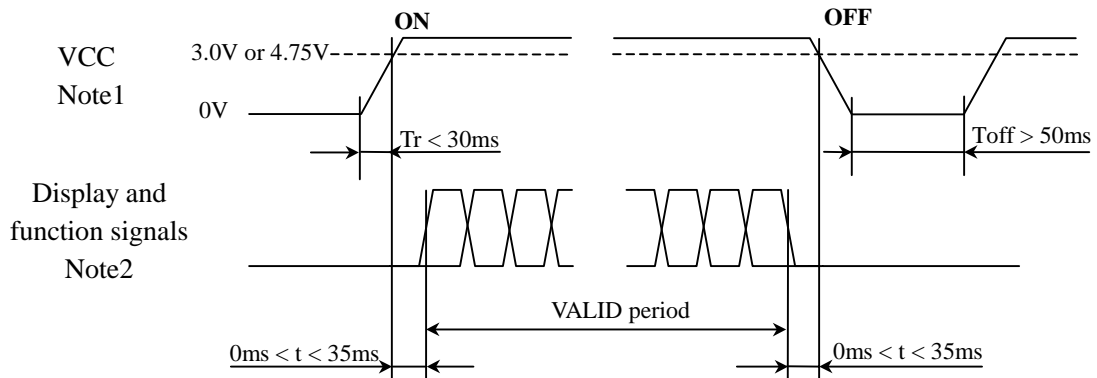

Note1: In terms of voltage variation (voltage drop) while VCC rising edge is below 3.0V in "VCC = 3.3V" or 4.75V in "VCC = 5.0V", a protection circuit may work, and then this product may not work.

Note2: Display (CLK, Hsync, Vsync, DE, R0 to R5, G0 to G5, B0 to B5) and function (DPS) signal must be Low or High-impedance, exclude the VALID period (See above sequence diagram), in order to avoid that internal circuits is damaged.

If some of display and function signals of this product are cut while this product is working, even if the signal input to it once again, it might not work normally. If customer stops the display and function signals, they should be cut VCC.

4.4.2 Sequence for backlight inverter (Option)

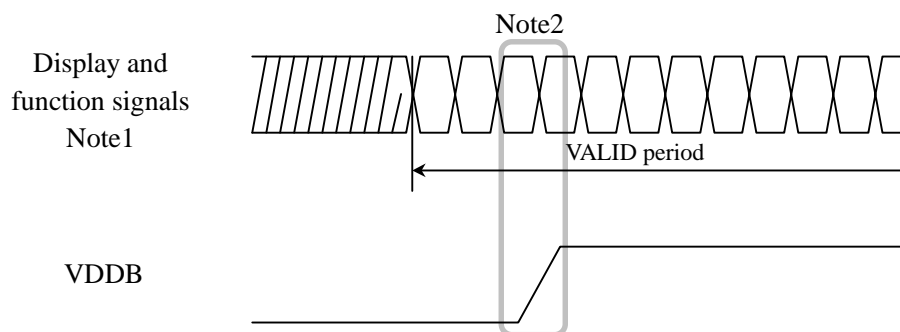

Note1: These are the display and function signals for LCD panel signal processing board.

Note2: The backlight inverter voltage (VDDB) should be inputted within the valid period of display and function signals, in order to avoid unstable data display.

4.5 CONNECTIONS AND FUNCTIONS FOR INTERFACE PINS

4.5.1 LCD panel signal processing board

CN1 socket (LCD module side): DF9C-31P-1V (Hirose Electric Co., Ltd.)

Adaptable plug: DF9-31S-1V (Hirose Electric Co., Ltd.)

Pin No.	Symbol	Signal	Remarks
1	GND	Ground	
2	CLK	Dot clock	
3	Hsync	Horizontal synchronous	-
4	Vsync	Vertical synchronous	
5	GND	Ground	
6	R0	Red data (LSB)	Least significant bit
7	R1	Red data	
8	R2	Red data	-
9	R3	Red data	
10	R4	Red data	
11	R5	Red data (MSB)	Most significant bit
12	GND	Ground	-
13	G0	Green data (LSB)	Least significant bit
14	G1	Green data	
15	G2	Green data	-
16	G3	Green data	
17	G4	Green data	
18	G5	Green data (MSB)	Most significant bit
19	GND	Ground	-
20	B0	Blue data (LSB)	Least significant bit
21	B1	Blue data	
22	B2	Blue data	-
23	B3	Blue data	
24	B4	Blue data	
25	B5	Blue data (MSB)	Most significant bit
26	GND	Ground	-
27	DE	Selection of DE / Fixed mode	Data enable signal: DE mode High or Open: Fixed mode Note1
28	VCC	Power supply	
29	VCC	Power supply	-
30	N.C.	-	Keep this terminal Open.
31	DPS	Selection of scan direction	High: Reverse scan Low or Open: Normal scan Note1

Note1: See "4.8 SCANNING DIRECTIONS".

4.5.2 Backlight lamp

Attention: VBLH and VBLC must be connected correctly. If customer connects wrongly, customer will be hurt and the module will be broken.

CN2 plug: BHR-03VS-1 (J.S.T Mfg. Co., Ltd.)

Adaptable socket: SM03 (4.0) B-BHS-TB (J.S.T Mfg. Co., Ltd.)

Pin No.	Symbol	Signal	Remarks
1	VBLC	Low voltage (Cold)	Cable color: Gray
2	VBLH	High voltage (Hot)	Cable color: White
3	VBLH	High voltage (Hot)	Cable color: White

4.5.3 Positions of plugs and a socket

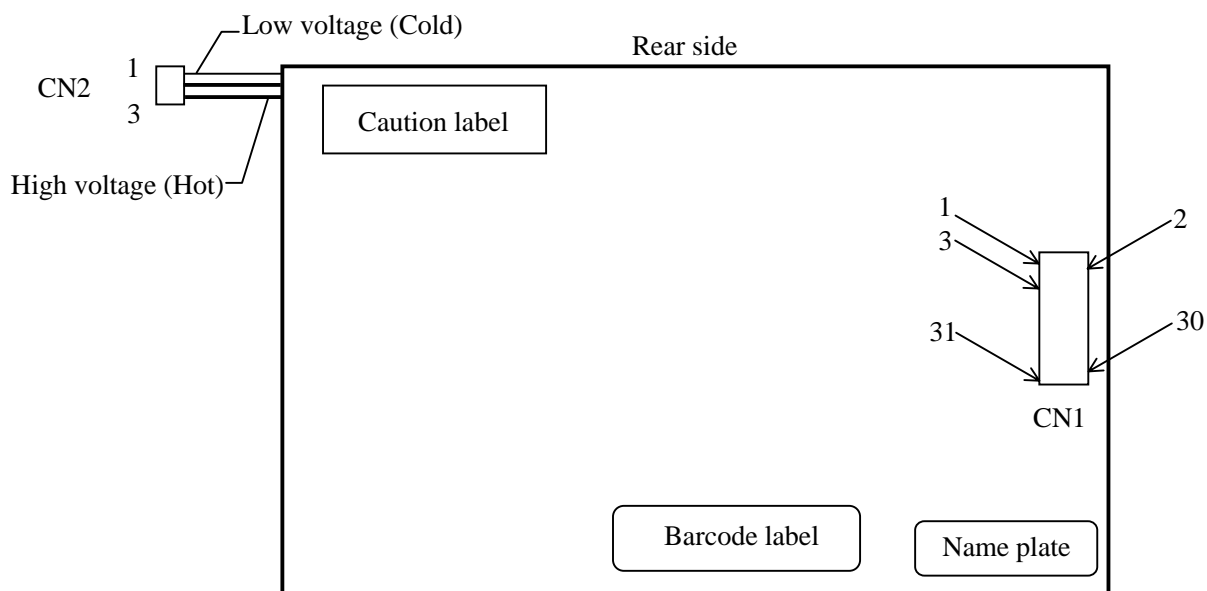

PRELIMINARY

4.6 DISPLAY COLORS AND INPUT DATA SIGNALS

This product can display in equivalent to 262,144 colors in 64 scale. Also the relation between display colors and input data signals is as the following table.

Display colors		Data signal (0: Low level, 1: High level)																	
		R5	R4	R3	R2	R1	R0	G5	G4	G3	G2	G1	G0	B5	B4	B3	B2	B1	B0
Basic colors	Black	0	0	0	0	0	0	0	0	0	0	0	0	0	0	0	0	0	0
	Blue	0	0	0	0	0	0	0	0	0	0	0	0	1	1	1	1	1	1
	Red	1	1	1	1	1	1	0	0	0	0	0	0	0	0	0	0	0	0
	Magenta	1	1	1	1	1	1	0	0	0	0	0	0	1	1	1	1	1	1
	Green	0	0	0	0	0	0	1	1	1	1	1	1	0	0	0	0	0	0
	Cyan	0	0	0	0	0	0	1	1	1	1	1	1	1	1	1	1	1	1
	Yellow	1	1	1	1	1	1	1	1	1	1	1	1	0	0	0	0	0	0
	White	1	1	1	1	1	1	1	1	1	1	1	1	1	1	1	1	1	1
Red scale	Black	0	0	0	0	0	0	0	0	0	0	0	0	0	0	0	0	0	0
		0	0	0	0	0	1	0	0	0	0	0	0	0	0	0	0	0	0
	dark	0	0	0	0	1	0	0	0	0	0	0	0	0	0	0	0	0	0
	↑				:														
	↓				:														
	bright	1	1	1	1	0	1	0	0	0	0	0	0	0	0	0	0	0	0
Red	1	1	1	1	1	0	0	0	0	0	0	0	0	0	0	0	0	0	
Red	1	1	1	1	1	1	0	0	0	0	0	0	0	0	0	0	0	0	
Green scale	Black	0	0	0	0	0	0	0	0	0	0	0	0	0	0	0	0	0	0
		0	0	0	0	0	0	0	0	0	1	0	0	0	0	0	0	0	0
	dark	0	0	0	0	0	0	0	0	0	1	0	0	0	0	0	0	0	0
	↑				:														
	↓				:														
	bright	0	0	0	0	0	0	1	1	1	1	0	1	0	0	0	0	0	0
Green	0	0	0	0	0	0	1	1	1	1	1	0	0	0	0	0	0	0	
Green	0	0	0	0	0	0	1	1	1	1	1	1	0	0	0	0	0	0	
Blue scale	Black	0	0	0	0	0	0	0	0	0	0	0	0	0	0	0	0	0	0
		0	0	0	0	0	0	0	0	0	0	0	0	0	0	0	0	0	1
	dark	0	0	0	0	0	0	0	0	0	0	0	0	0	0	0	0	1	0
	↑				:														
	↓				:														
	bright	0	0	0	0	0	0	0	0	0	0	0	0	1	1	1	1	0	1
Blue	0	0	0	0	0	0	0	0	0	0	0	0	1	1	1	1	1	0	
Blue	0	0	0	0	0	0	0	0	0	0	0	0	1	1	1	1	1	1	

4.7 DISPLAY POSITIONS

The following table is the coordinates per pixel (See "4.8 SCANNING DIRECTIONS".).

$C(0, 0)$									
<table border="1" style="margin: auto; border-collapse: collapse;"> <tr> <td style="padding: 2px 10px;">R</td> <td style="padding: 2px 10px;">G</td> <td style="padding: 2px 10px;">B</td> </tr> </table>							R	G	B
R	G	B							
$C(0, 0)$	$C(1, 0)$...	$C(X, 0)$...	$C(638, 0)$	$C(639, 0)$			
$C(0, 1)$	$C(1, 1)$...	$C(X, 1)$...	$C(638, 1)$	$C(639, 1)$			
⋮	⋮	⋮	⋮	⋮	⋮	⋮			
$C(0, Y)$	$C(1, Y)$...	$C(X, Y)$...	$C(638, Y)$	$C(639, Y)$			
⋮	⋮	⋮	⋮	⋮	⋮	⋮			
$C(0, 478)$	$C(1, 478)$...	$C(X, 478)$...	$C(638, 478)$	$C(639, 478)$			
$C(0, 479)$	$C(1, 479)$...	$C(X, 479)$...	$C(638, 479)$	$C(639, 479)$			

4.8 SCANNING DIRECTIONS

The following figures are seen from a front view. Also the arrow shows the direction of scan.

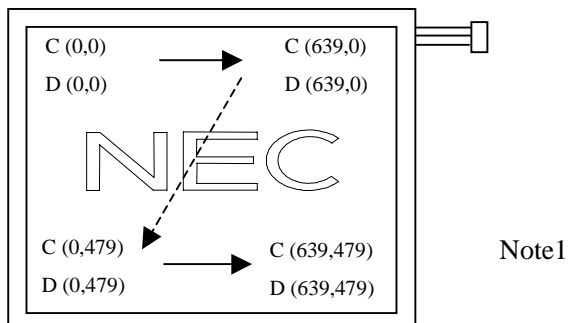

Figure 1. Normal scan (DPS: Low or Open)

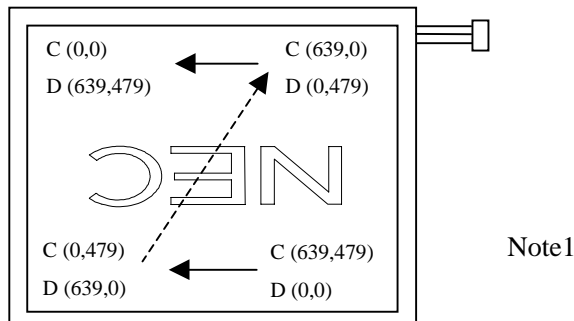

Figure 2. Reverse scan (DPS: High)

Note1: Meaning of C (X, Y) and D (X, Y)

C (X, Y): The coordinates of the display position (See "4.7 DISPLAY POSITIONS".)

D (X, Y): The data number of input signal for LCD panel signal processing board

4.9 INPUT SIGNAL TIMINGS FOR LCD PANEL SIGNAL PROCESSING BOARD

4.9.1 Outline of input signal timings

- Horizontal signal

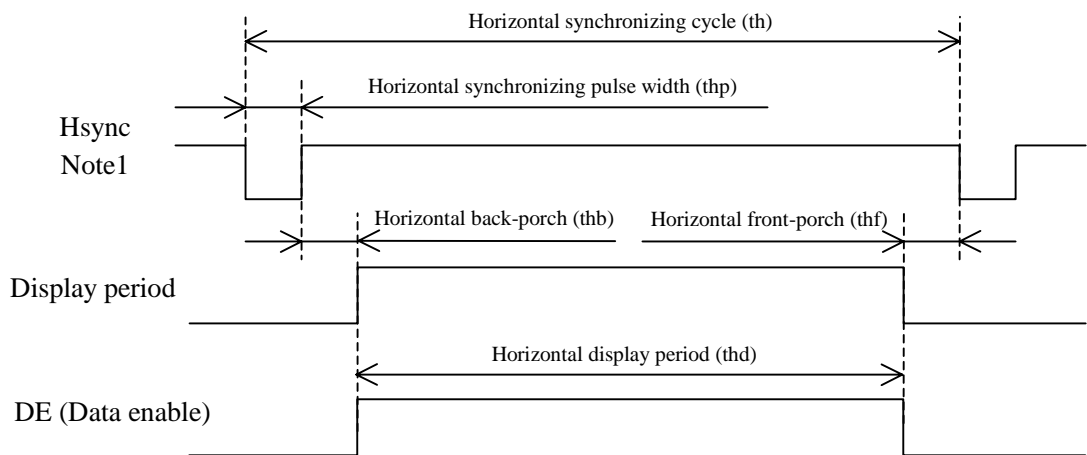

- Vertical signal

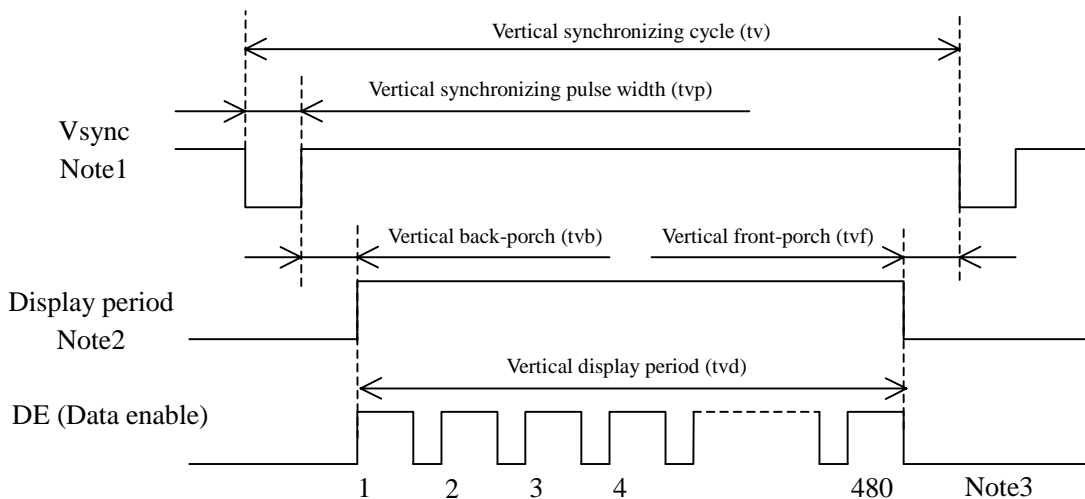

Note1: Fixed mode cannot be used while working of DE mode.

Note2: This diagram indicates virtual signal for set up to timing.

Note3: See "4.9.3 Input signal timing chart" for numeration of pulse.

PRELIMINARY

4.9.2 Timing characteristics

(a) Fixed mode

(Note1)

Parameter		Symbol	min.	typ.	max.	Unit	Remarks	
CLK	Frequency	1/tc	21.0	25.175	29.0	MHz	39.72 ns (typ.)	
	Duty	tcd	0.4	0.5	0.6	-	-	
	Rise time, Fall time	tcrf	-	-	10	ns	-	
DATA (R0-R5) (G0-G5) (B0-B5)	CLK-DATA	Setup time	tds	8	-	-	ns	-
		Hold time	tdh	12	-	-	ns	
	Rise time, Fall time	tdrf	-	-	10	ns		
Hsync	Cycle	th	30.0	31.778	33.6	μs	31.468 kHz (typ.)	
			800			CLK	Note2	
	Display period	thd	640			CLK		
	Front-porch	thf	16			CLK		
	Pulse width	thp	10	96	-	CLK		
	Back-porch	thb	-	48	134	CLK		
	Total of pulse width and back-porch	thp + thb	144			CLK		
	CLK- Hsync	Setup time	ths	8	-	-	ns	-
		Hold time	thh	12	-	-	ns	
Rise time, Fall time	thrf	-	-	10	ns			
Vsync	Cycle	tv	16.1	16.683	17.2	ms	59.94 Hz (typ.)	
			525			H	Note2	
	Display period	tvd	480			H		
	Front-porch	tvf	12			H		
	Pulse width	tvp	1	2	-	H		
	Back-porch	tvb	-	31	32	H		
	Total of pulse width and back-porch	tvp + tvb	33			H		
	Hsync-Vsync timing	thv	1	-	-	CLK	-	
	Vsync-Hsync timing	tvh	30	-	-	ns		
Rise time, Fall time	tvrf	-	-	10	ns			

Note1: Definition of parameters is as follows.

$$tc = 1CLK, tcd = tch/tc, th = 1H$$

Note2: Keep tvp + tvb and thp + thb within the table. If it is out of specification, display position will be shifted to right/left side or up/down.

PRELIMINARY

(b) DE mode

(Note1, Note2)

Parameter		Symbol	min.	typ.	max.	Unit	Remarks	
CLK	Frequency	1/tc	21.0	25.175	29.0	MHz	39.72 ns (typ.)	
	Duty	tcd	0.4	0.5	0.6	-	-	
	Rise time, Fall time	tcrf	-	-	10	ns	-	
DATA (R0-R5) (G0-G5) (B0-B5)	CLK-DATA	Setup time	tds	8	-	-	ns	-
		Hold time	tdh	12	-	-	ns	
	Rise time, Fall time	tdrf	-	-	10	ns		
Vsync	Pulse width		typ	1	2	-	H	-
	Vsync-DE timing	Setup time	tvds	1	-	-	CLK	
		Hold time	tvdh	1	-	-	CLK	
	Rise time, Fall time		tvrf	-	-	10	μs	
DE	Horizontal	Cycle	th	30.0	31.778	33.6	μs	31.468 kHz (typ.)
			-	-	800	-	CLK	-
		Display period	thd	640			CLK	-
	Vertical (One frame)	Cycle	tv	16.1	16.683	17.2	ms	59.94 Hz (typ.)
			-	-	525	-	H	-
		Display period	tvd	480			H	-
	CLK-DE	Setup time	tdes	8	-	-	ns	-
Hold time		tdeh	12	-	-	ns		
	Rise time, Fall time		tderf	-	-	10	ns	

Note1: Definition of parameters is as follows.

$$tc = 1\text{CLK}, tcd = tch/tc, th = 1H$$

Note2: Hsync signal (Pin No.3 of CN1) is not used inside the product at DE mode.

Do not keep pin open to avoid noise problem.

4.9.3 Input signal timing chart

(a) Fixed mode

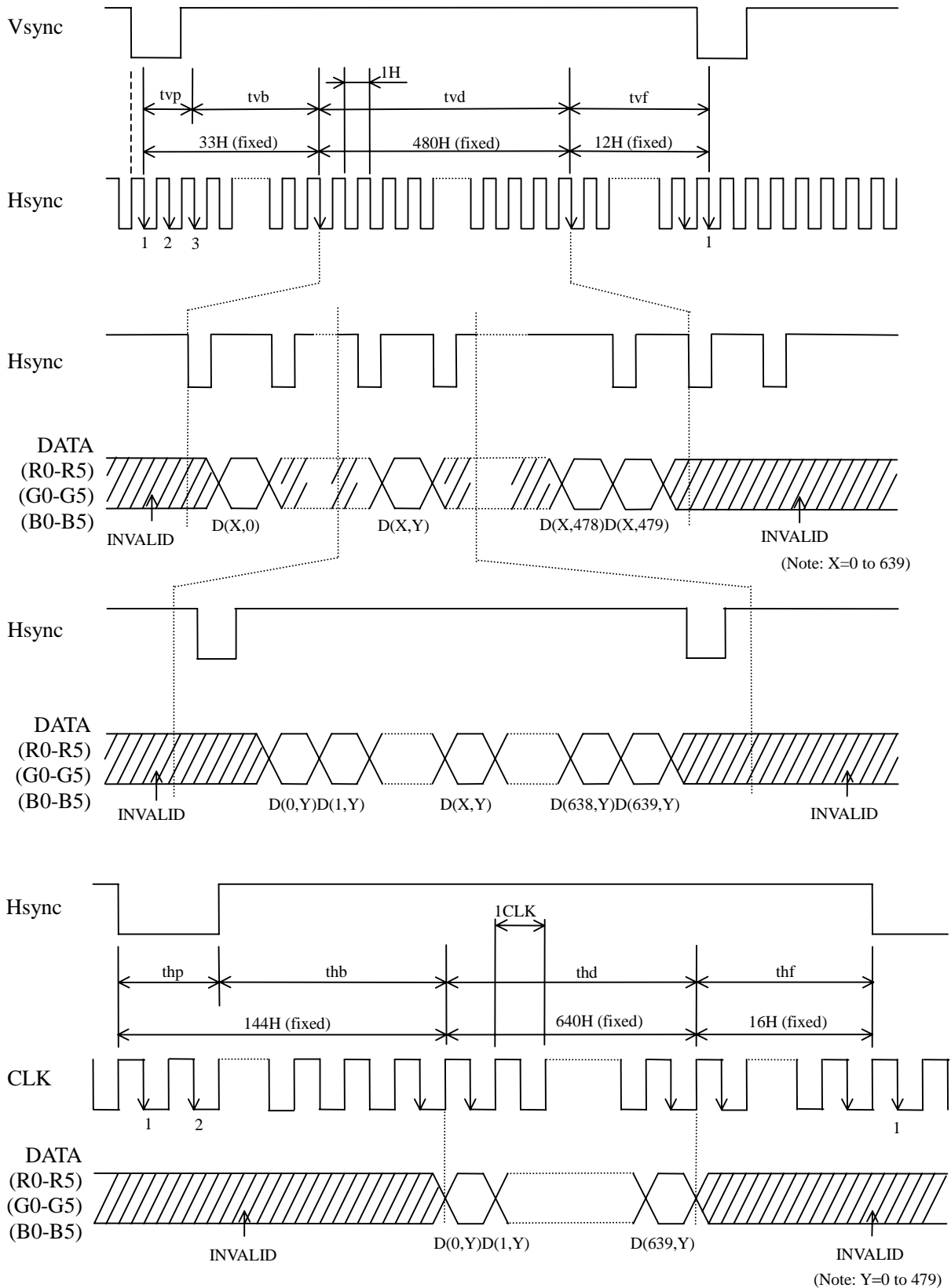

(b) DE mode

Horizontal timing

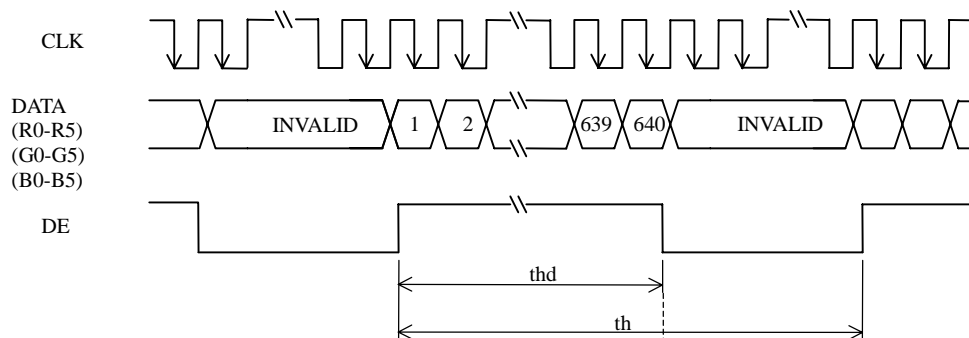

Vertical timing

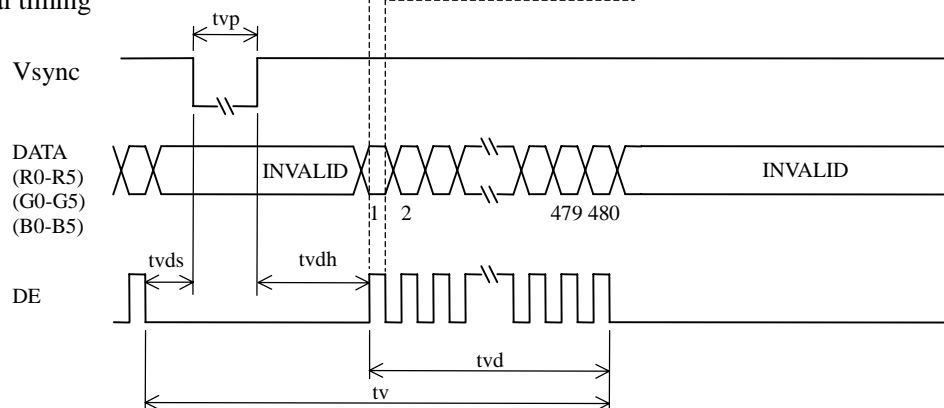

PRELIMINARY

(c) Common

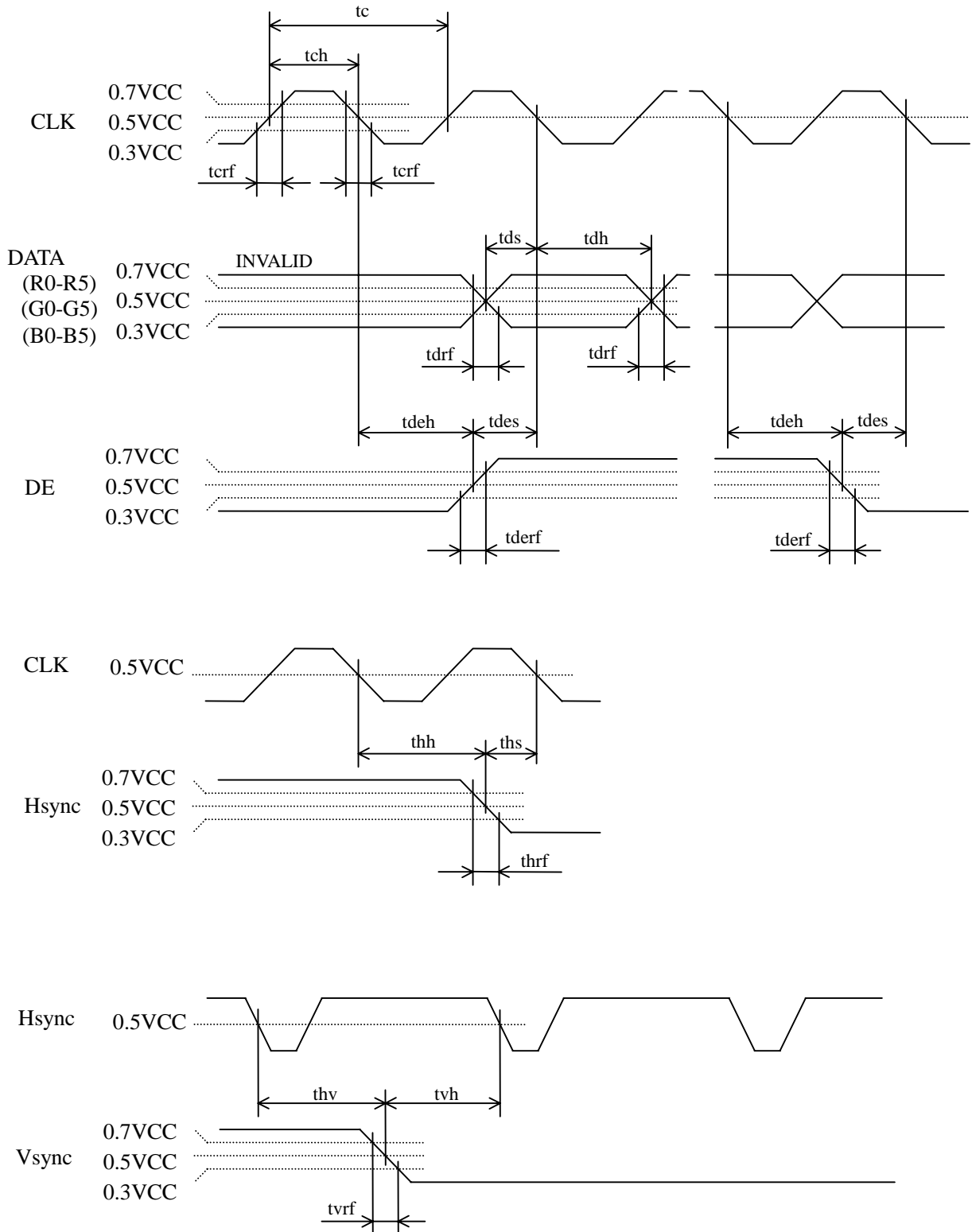

4.10 OPTICS

4.10.1 Optical characteristics

(Note1)

Parameter	Note2	Condition	Symbol	min.	typ.	max.	Unit	Remarks
Luminance		White at center $\theta R = 0^\circ, \theta L = 0^\circ, \theta U = 0^\circ, \theta D = 0^\circ$	L	TBD	450	-	cd/m ²	-
Contrast ratio		White/Black at center $\theta R = 0^\circ, \theta L = 0^\circ, \theta U = 0^\circ, \theta D = 0^\circ$	CR	TBD	600	-	-	Note3
Luminance uniformity		-	LU	-	1.25	1.40	-	Note4
Chromaticity	White	x coordinate	Wx	TBD	TBD	TBD	-	Note5
		y coordinate	Wy	TBD	TBD	TBD	-	
	Red	x coordinate	Rx	-	TBD	-	-	
		y coordinate	Ry	-	TBD	-	-	
	Green	x coordinate	Gx	-	TBD	-	-	
		y coordinate	Gy	-	TBD	-	-	
Blue	x coordinate	Bx	-	TBD	-	-		
	y coordinate	By	-	TBD	-	-		
Color gamut		$\theta R = 0^\circ, \theta L = 0^\circ, \theta U = 0^\circ, \theta D = 0^\circ$ at center, against NTSC color space	C	TBD	43	-	%	
Response time		White to Black	Ton	-	TBD	TBD	ms	Note6 Note7
		Black to White	Toff	-	TBD	TBD	ms	
Viewing angle	Right	$\theta U = 0^\circ, \theta D = 0^\circ, CR = 10$	θR	TBD	70	-	°	Note8
	Left	$\theta U = 0^\circ, \theta D = 0^\circ, CR = 10$	θL	TBD	70	-	°	
	Up	$\theta R = 0^\circ, \theta L = 0^\circ, CR = 10$	θU	TBD	45	-	°	
	Down	$\theta R = 0^\circ, \theta L = 0^\circ, CR = 10$	θD	TBD	55	-	°	

Note1: These are initial characteristics.

Note2: Measurement conditions are as follows.

Ta=25°C, VCC=3.3V, IBL= 5.0mArms/lamp, Display mode: VGA, Horizontal cycle = 31.468kHz, Vertical cycle = 59.94Hz, DPS= Low or Open: Normal scan

Optical characteristics are measured at luminance saturation after 20minutes from working the product, in the dark room. Also measurement method for luminance is as follows.

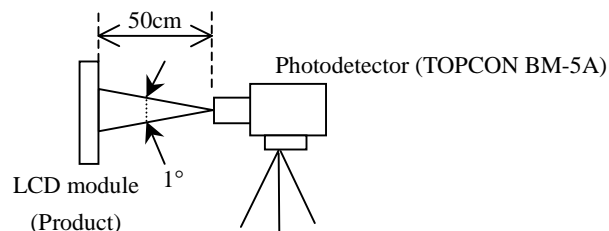

Note3: See "4.10.2 Definition of contrast ratio".

Note4: See "4.10.3 Definition of luminance uniformity".

Note5: These coordinates are found on CIE 1931 chromaticity diagram.

Note6: Product surface temperature: TopF = TBD °C

Note7: See "4.10.4 Definition of response times".

Note8: See "4.10.5 Definition of viewing angles".

4.10.2 Definition of contrast ratio

The contrast ratio is calculated by using the following formula.

$$\text{Contrast ratio (CR)} = \frac{\text{Luminance of white screen}}{\text{Luminance of black screen}}$$

4.10.3 Definition of luminance uniformity

The luminance uniformity is calculated by using following formula.

$$\text{Luminance uniformity (LU)} = \frac{\text{Maximum luminance from ① to ⑤}}{\text{Minimum luminance from ① to ⑤}}$$

The luminance is measured at near the 5 points shown below.

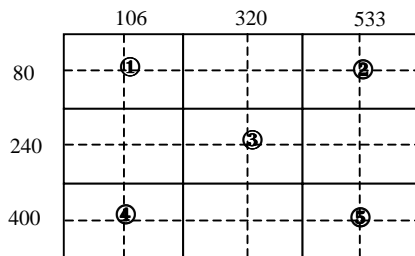

4.10.4 Definition of response times

Response time is measured, the luminance changes from "white" to "black", or "black" to "white" on the same screen point, by photo-detector. Ton is the time it takes the luminance change from 90% down to 10%. Also Toff is the time it takes the luminance change from 10% up to 90% (See the following diagram.).

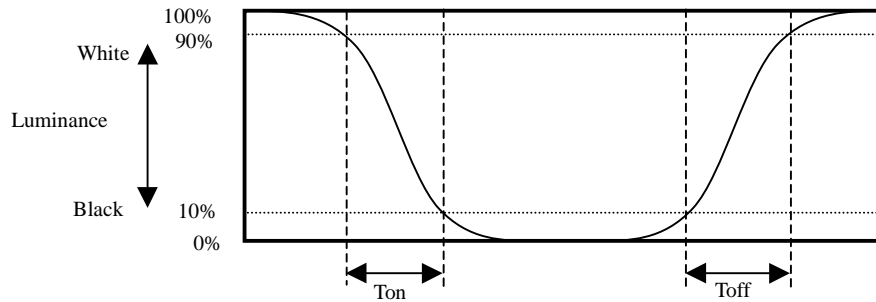

4.10.5 Definition of viewing angles

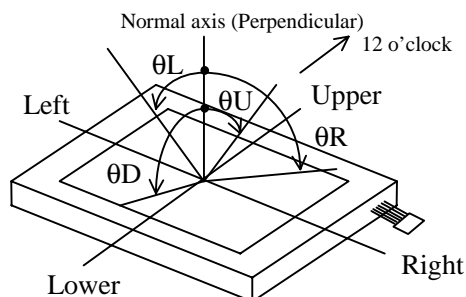

5. RELIABILITY TESTS

Test item	Condition	Judgement
High temperature and humidity (Operation)	① $60 \pm 2^\circ\text{C}$, RH = 90%, 240hours ② Display data is black.	No display malfunctions Note1
High temperature (Operation)	① $70 \pm 2^\circ\text{C}$, 240hours ② Display data is black.	
Heat cycle (Operation)	① $-10 \pm 3^\circ\text{C}$...1hour $70 \pm 3^\circ\text{C}$...1hour ② 50cycles, 4hours/cycle ③ Display data is black.	
Thermal shock (Non operation)	① $-20 \pm 3^\circ\text{C}$...30minutes $80 \pm 3^\circ\text{C}$...30minutes ② 100cycles, 1hour/cycle ③ Temperature transition time is within 5 minutes.	
ESD (Operation)	① 150pF, 150Ω, $\pm 10\text{kV}$ ② 9 places on a panel surface Note2 ③ 10 times each places at 1 sec interval	
Dust (Operation)	① Sample dust: No. 15 (by JIS-Z8901) ② 15 seconds stir ③ 8 times repeat at 1 hour interval	
Vibration (Non operation)	① 5 to 100Hz, 19.6m/s^2 ② 1 minute/cycle ③ X, Y, Z direction ④ 120 times each directions	No display malfunctions No physical damages Note1
Mechanical shock (Non operation)	① 539m/s^2 , 11ms ② $\pm X$, $\pm Y$, $\pm Z$ direction ③ 5 times each directions	

Note1: Display and appearance are checked under environmental conditions equivalent to the inspection conditions of defect criteria.

Note2: See the following figure for discharge points.

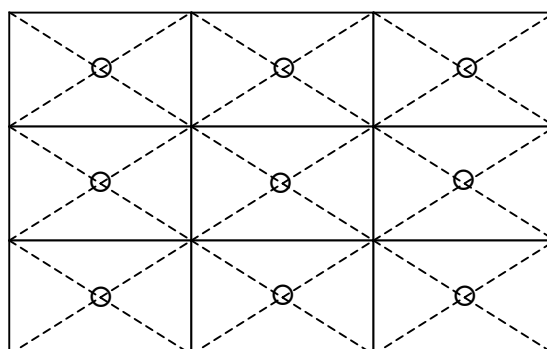

6. PRECAUTIONS

6.1 MEANING OF CAUTION SIGNS

The following caution signs have very important meaning. **Be sure to read "10.2 CAUTIONS" and "10.3 ATTENTIONS", after understanding this contents!**



This sign has the meaning that customer will be injured by himself or the product will sustain a damage, if customer has wrong operations.



This sign has the meaning that customer will get an electrical shock, if customer has wrong operations.



This sign has the meaning that customer will be injured by himself, if customer has wrong operations.

6.2 CAUTIONS



*** Do not touch the working backlight. Customer will be in danger of an electric shock.**



*** Do not touch the working backlight. Customer will be in danger of burn injury.
* Do not shock and press the LCD panel and the backlight! There is a danger of breaking, because they are made of glass. (Shock: To be not greater 539m/s² and to be not greater 11ms, Pressure: To be not greater 19.6 N)**

6.3 ATTENTIONS



6.3.1 Handling of the product

- ① Take hold of both ends without touch the circuit board cover when customer pulls out products (LCD modules) from inner packing box. If customer touches it, products may be broken down or out of adjustment, because of stress to mounting parts.
- ② Do not hook cables nor pull connection cables such as lamp cable and so on, for fear of damage.
- ③ If customer puts down the product temporarily, the product puts on flat subsoil as a display side turns down.
- ④ Take the measures of electrostatic discharge such as earth band, ionic shower and so on, when customer deals with the product, because products may be damaged by electrostatic.
- ⑤ The torque for mounting screws must never exceed 0.294N·m. Higher torque values might result in distortion of the bezel.
- ⑥ The product must be installed using mounting holes without undue stress such as bends or twist (See outline drawings). And do not add undue stress to any portion (such as bezel flat area) except mounting hole portion.
Bends or twist described above and undue stress to any portion except mounting hole portion may cause display un-uniformity.

- ⑦ Do not press or rub on the sensitive display surface. If customer clean on the panel surface, NEC recommends using the cloth with ethanolic liquid such as screen cleaner for LCD.
- ⑧ Do not push-pull the interface connectors while the product is working, because wrong power sequence may break down the product.
- ⑨ Do not bend or unbend the lamp cable at the near part of the lamp holding rubber, to avoid the damage for high voltage side of the lamp. This damage may cause a lamp breaking and abnormal operation of high voltage circuit.

6.3.2 Environment

- ① Do not operate or store in high temperature, high humidity, dewdrop atmosphere or corrosive gases. Keep the product in antistatic pouch in room temperature, because of avoidance for dusts and sunlight, if customer stores the product.
- ② In order to prevent dew condensation occurring by temperature difference, the product packing box must be opened after leave under the environment of an unpacking room temperature enough. Because a situation of dew condensation occurring is changed by the environmental temperature and humidity, evaluate the leaving time sufficiently. (Recommendation leaving time: 6 hour or more with packing state)
- ③ Do not operate in high magnetic field. Circuit boards may be broken down by it.
- ④ This product is not designed as radiation hardened.
- ⑤ Use an original protection sheet on the product surface (polarizer). Adhesive type protection sheet should be avoided, because it may change color or properties of the polarizer.

6.3.3 Characteristics

The following items are neither defects nor failures.

- ① Response time, luminance and color may be changed by ambient temperature.
- ② The LCD may be seemed luminance non-uniformity, flicker, vertical seam or small spot by display patterns.
- ③ Optical characteristics (e.g. luminance, display uniformity, etc.) gradually is going to change depending on operating time, and especially low temperature, because the LCD has cold cathode fluorescent lamps.
- ④ Do not display the fixed pattern for a long time because it may cause image sticking. Use a screen saver, if the fixed pattern is displayed on the screen.
- ⑤ The display color may be changed by viewing angle because of the use of condenser sheet in the backlight.
- ⑥ Optical characteristics may be changed by input signal timings.
- ⑦ The interference noise of input signal frequency for this product's signal processing board and luminance control frequency of customer's backlight inverter may appear on a display. Set up luminance control frequency of backlight inverter so that the interference noise does not appear.

6.3.4 Other

- ① All GND, backlight inverter ground (GNDB), VCC and backlight inverter power supply voltage (VDDDB) terminals should be used without a non-connected line.
- ② Do not disassemble a product or adjust volume without permission of NEC.
- ③ See "REPLACEMENT MANUAL FOR LAMP HOLDER SET", if customer would like to replace backlight lamps.
- ④ Pay attention not to insert waste materials inside of products, if customer uses screw nails.
- ⑤ Pack the product with original shipping package, because of avoidance of some damages during transportation, when customer returns it to NEC for repair and so on.

7. OUTLINE DRAWINGS

7.1 FRONT VIEW

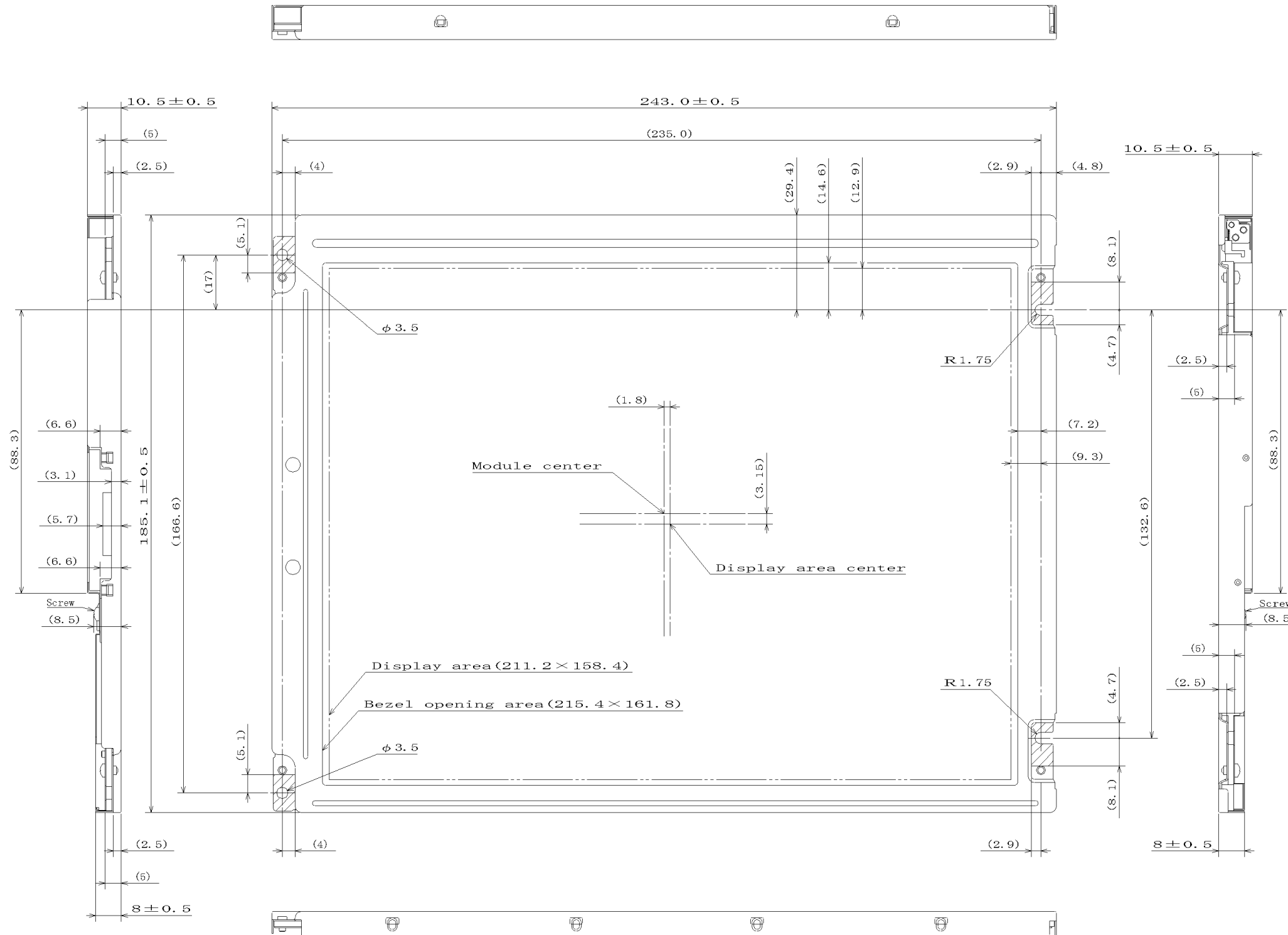

Note1: The values in parentheses are for reference.

Note2: The torque for mounting screws must never exceed 0.294N·m.

Note3:  Mounting hole portions (4 pieces)

Unit: mm

7.2 REAR VIEW

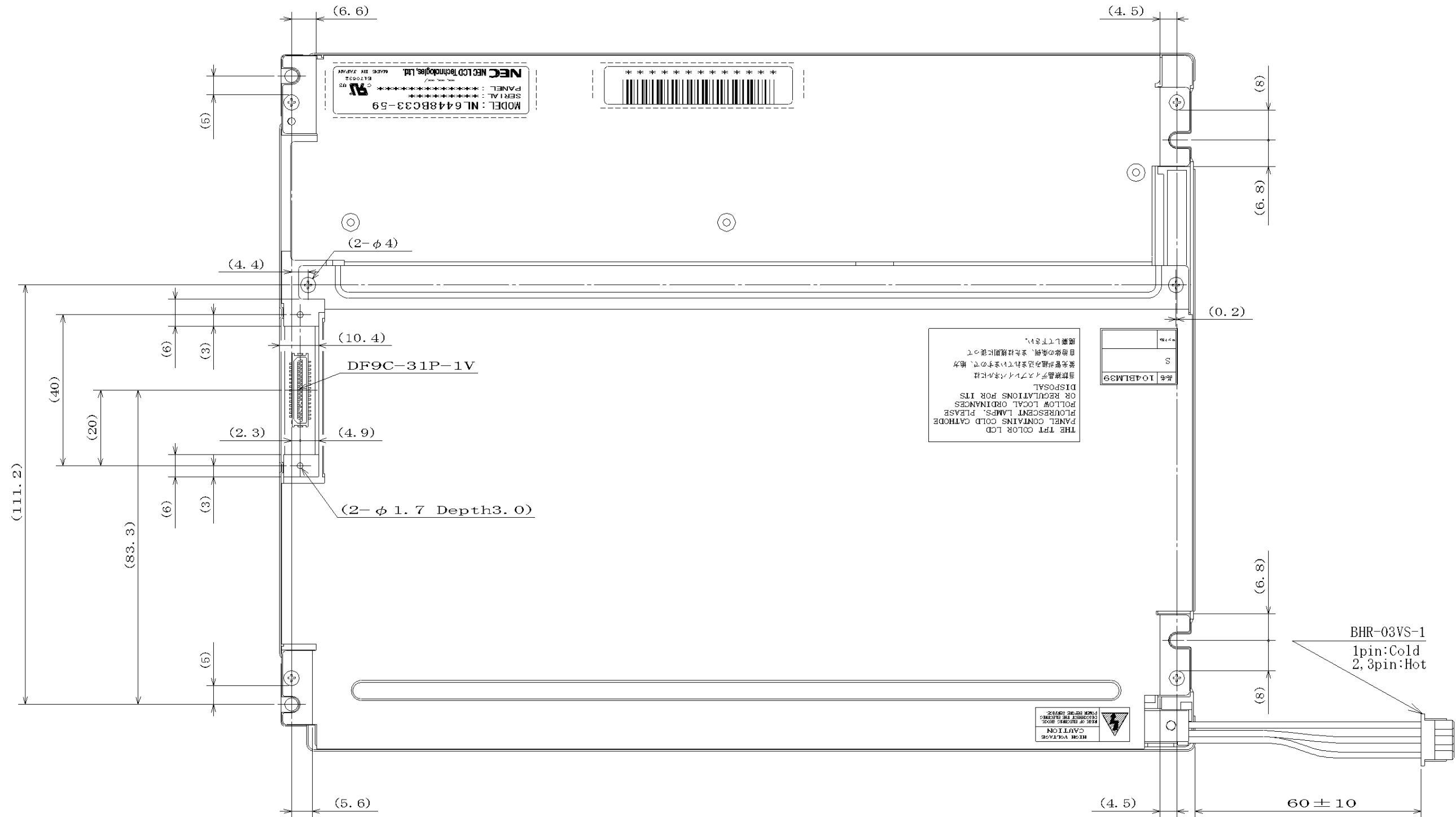



Note1: The values in parentheses are for reference.
 Note2: The torque for mounting screws must never exceed 0.294N·m.

Unit: mm

PRELIMINARY

REVISION HISTORY

The inside of latest specifications is revised to the clerical error and the major improvement of previous edition. Only a changed part such as functions, characteristic value and so on that may affect a design of customers, are described especially below.

Edition	Document number	Prepared date	Revision contents and signature									
1st edition	DOD-PD-0090	June 24, 2003	<p data-bbox="517 589 730 645">Revision contents</p> <p data-bbox="517 627 638 649">New issue</p> <p data-bbox="542 725 742 748">Signature of writer</p> <table data-bbox="558 772 1404 907"><tr><td data-bbox="558 772 837 806"><i>Approved by</i></td><td data-bbox="861 772 1101 806"><i>Checked by</i></td><td data-bbox="1109 772 1404 806"><i>Prepared by</i></td></tr><tr><td data-bbox="558 817 837 862"></td><td data-bbox="861 817 1101 862">_____</td><td data-bbox="1109 817 1404 862"><i>R. Kawashima</i></td></tr><tr><td data-bbox="558 862 837 907">T. ITO</td><td data-bbox="861 862 1101 907">_____</td><td data-bbox="1109 862 1404 907">R. KAWASHIMA</td></tr></table>	<i>Approved by</i>	<i>Checked by</i>	<i>Prepared by</i>		_____	<i>R. Kawashima</i>	T. ITO	_____	R. KAWASHIMA
<i>Approved by</i>	<i>Checked by</i>	<i>Prepared by</i>										
	_____	<i>R. Kawashima</i>										
T. ITO	_____	R. KAWASHIMA										